

Article number: 0102223

Description: Retaining ring J450 DIN472
Spring steel

Measures

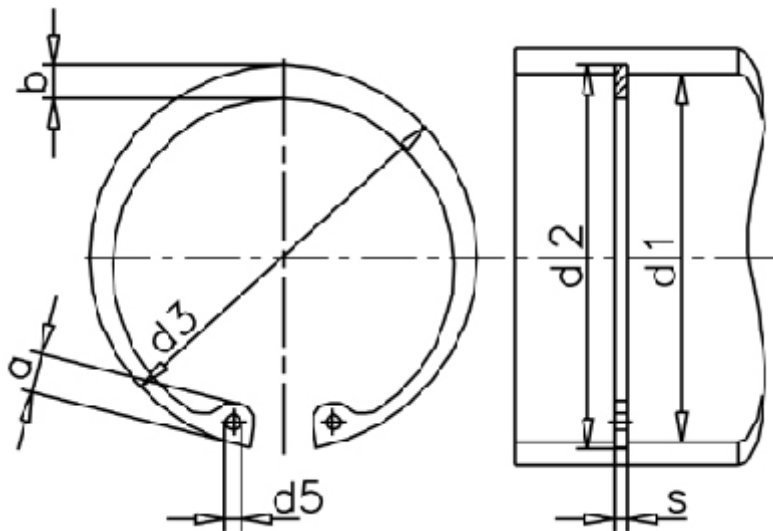

a max	=	FN kN	= 1431.00	t	= 6.00
AN mm ²	= 8590.0	FRg kN	= 138.0	tol	= +1,00
b	= 26.0	FR kN	= 1388.0	tol	= +2,00-1,00
d1	= 450	g	= 6.0	tol	= -0.15
d2	= 462.0	K kN-mm	= 3180.0	Tong	= ZGJ-5
d3	= 470.00	m min	= 7.20	Weight kg/1000	= 1510.00
d5 min	= 6.0	Nominal drive	= 18.0		
Description = J 450		s	= 7.00		